

Facsimile with Digital Cordless Phone

Quick Reference Guide

Model No. **KX-PW301DL**



KX-PW301DL

KX-PW301DL has one portable handset.

Thank you for purchasing a Panasonic facsimile.

Table of Contents

Finding the controls	2
Installations and connections	4
Setting the date and time	8
Setting your facsimile telephone number	8
Setting your logo	9
Character input and command key table	10
Automatic dialing on the main unit	11
Automatic dialing on the portable handset.....	12
Intercom between the main unit and portable handset	13
Sending faxes	14
Receiving faxes	15
Operating the built-in answering device	17
Using the hand scanner	18
Individual e-mail services	23
Connecting a computer	29
Connecting a BS digital tuner / Digital CS tuner	30
Specifications	31

- This guide explains some basic features and operations, but not all of them. For further details, see the Japanese operating instructions.
- This product is designed for use in Japan.
Panasonic cannot provide service for this product if used outside Japan.
- Any details given in this guide are subject to change without notice.

Finding the controls

Main unit (control panel)

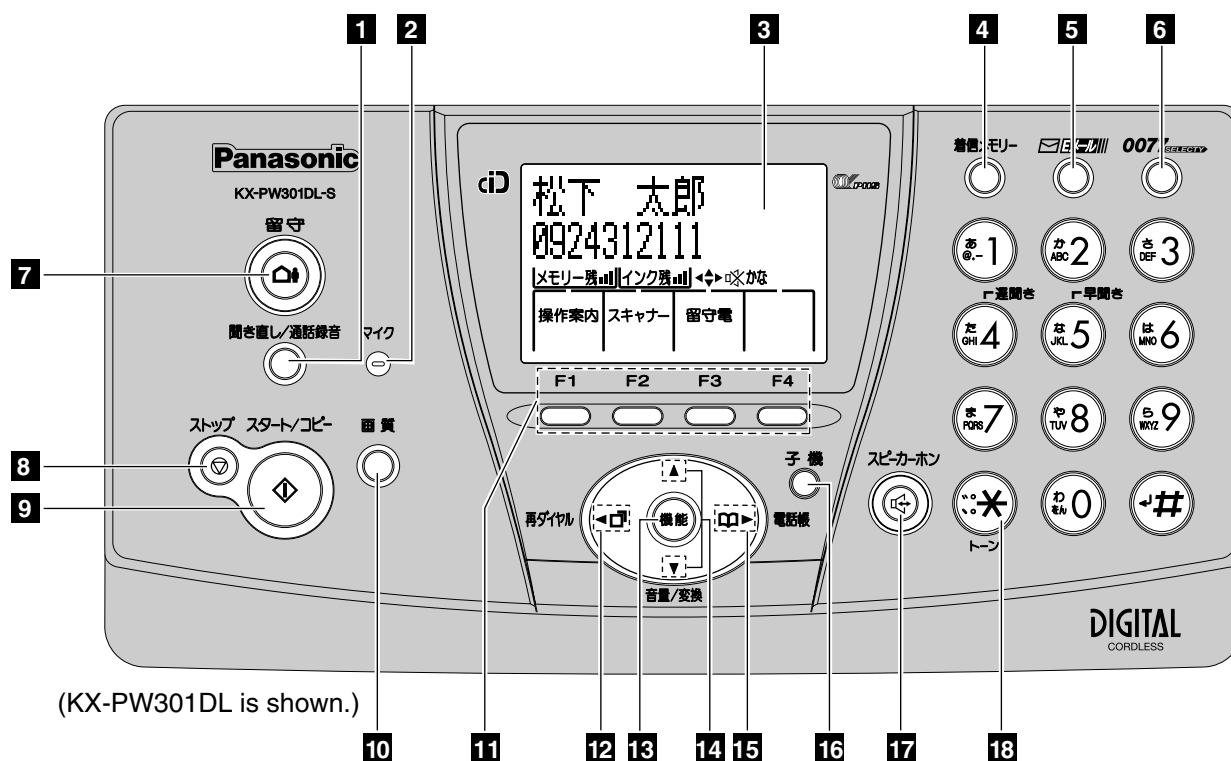

(KX-PW301DL is shown.)

- 11** **Multi-operation** buttons refer to the function displayed on the display panel.
- 3** **Liquid crystal display**
- 13** **Function** button initiates programming.
- 1** **Replay** button plays back recorded messages. / **Record** button records telephone calls.
- 7** **Auto Answer** button
—light on: answering device activated.
—light off: used as a regular telephone.
- 2** **Microphone**
- 15** **Store** button stores information (phone numbers, names etc.) into the telephone directory. / **Search** button searches the telephone directory.
- 14** **Search** button searches the directory by pressing the up and down buttons.
Volume button adjusts ringer, speaker and handset volume by pressing the up and down buttons.
- 9** **Start/Copy** button starts faxing or copying.
- 8** **Stop** button
- 16** **Intercom** button
- 6** **0077 SELECTY** button & indicator accesses 0077 SELECTY services.
- 17** **Speakerphone** button
- 12** **Redial** button
- 5** **E-Mail** button & indicator
- 4** **Call Memory** button & indicator stores the caller ID of incoming calls.
- 10** **Resolution** button selects the resolution when faxing or copying.
- 18** **Tone** button switches to tone dialing.

Finding the controls

Portable handset

How to use **key**

電話帳 To store/search in the directory.

再ダイヤル To redial the last number dialed.

音量 To adjust the volume.
To change the character input mode.

To view stored information:
Phonebook: Press , then press .

Dialed numbers: Press , then press .

How to view **key**

Indicates which directions the key can be tilted.

up down

up and down

left right

left and right

How to use **buttons**

F1 and F2 and F3 buttons refer to the function displayed on the bottom of the display. They function differently depending on the mode.

Fixed antenna

Speakerphone

Panasonic KX-FH501D-S

機能 (機能) 留守

F1 F2 F3

音量 内線

再ダイヤル 電話帳

外線 切 電源

あ 1 か 2 古 3

た 4 な 5 は 6

ま 7 や 8 ら 9

＊ 0 #

ファクス 充電 スピーカーホン

増設

How to use **buttons**

To make/answer calls.

To page the main unit.

To end a call.
To end or exit from editing or other operations.
To turn on/off the power by pressing for two seconds or longer.

How to use **buttons**

To receive faxes.
To insert a space.

To use the speakerphone.

(Charge indicator)
Charging Red
Full Off

Dial buttons

トーン To switch to Tone dialing mode.

#

Microphone
Do not cover the microphone while talking.

増設 Used when installing additional portable handsets.

Hand scanner

Battery indicator (Shows the amount of battery power left)

Operation indicator (Shows the condition of the scanner)

Memory indicator (Shows the amount of memory being used)

電池 メモリー 文字 写真 A4 B4

動作中 消去 画質 読取幅 スタート/ストップ

2秒間押し

Scanning width button

Resolution button

Delete button (To delete the last page of scanned content)

To start or stop scanning

Installations and connections

Installing the ink film

- 1 Open the control panel.

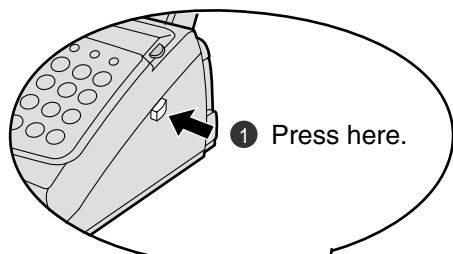

- 2 Open the control panel until it locks.

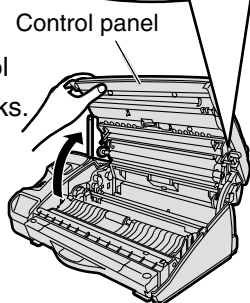

- 2 Insert the ink film.

- 1 Find the "T" shaped gear (blue).

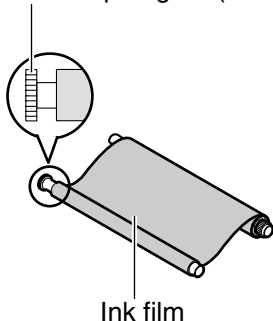

- 2 Insert the blue core into the right slot of the main unit.

- 3 Insert the "T" shaped gear (blue) into the left slot of the main unit.

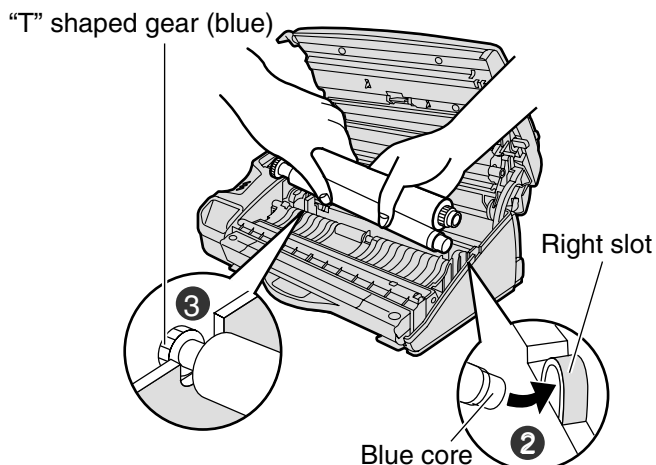

- 4 Insert the white core into the slots shown in the picture below.

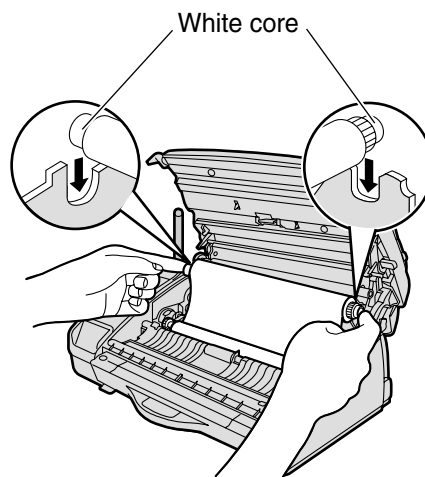

- 5 If the ink film is slack, tighten it by winding the "T" shaped gear.

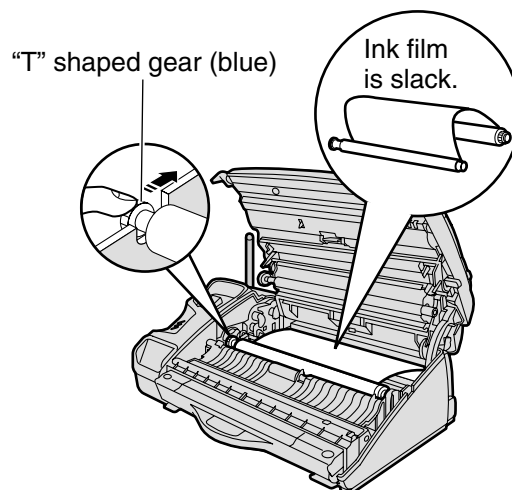

- 3 Close the control panel until it locks.

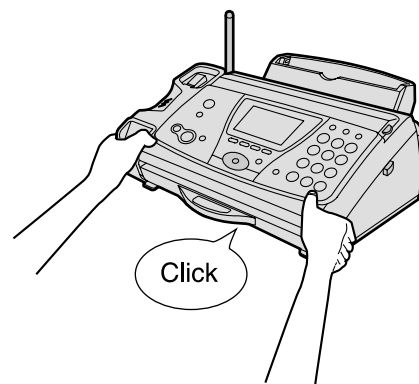

Installations and connections

Installing recording paper (A4 size)

1 Install the recording paper tray.

- 1 Insert the left tab on the recording paper tray into the left slot of the main unit.
- 2 Insert the right tab into the right slot of the main unit.

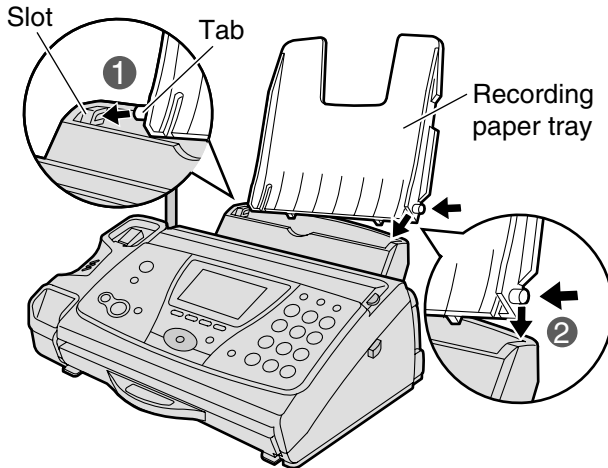

2 Insert the recording paper into the recording paper tray.

- 1 Open the paper entrance cover until it locks.

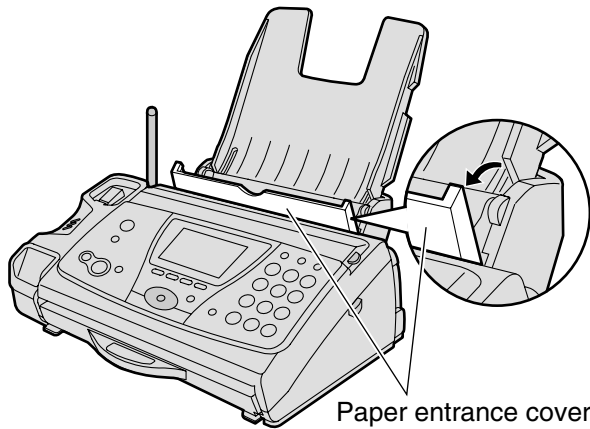

- 2 Fan the stack of recording paper (A4 size).
- 3 Insert the recording paper into the recording paper tray. (Up to 30 sheets)

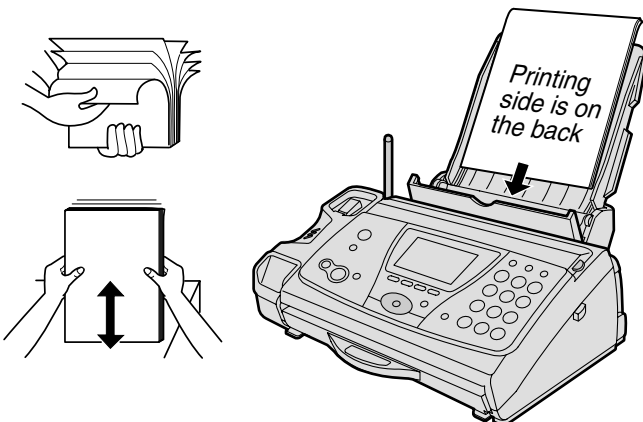

3 Close the paper entrance cover by leaning it back.

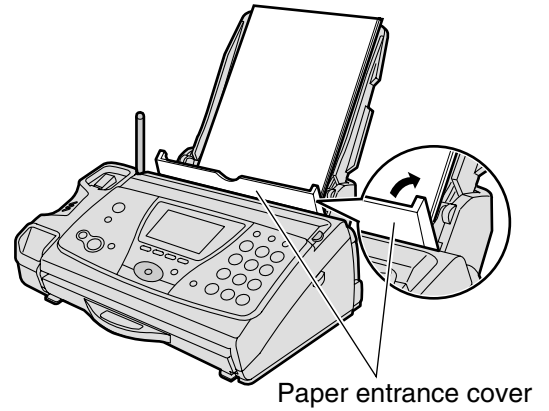

4 Install the recording paper cover on the recording paper tray by sliding it down from the top.

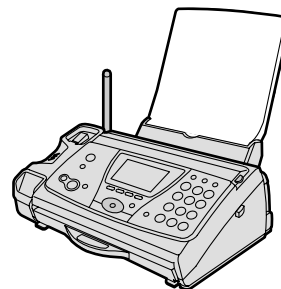
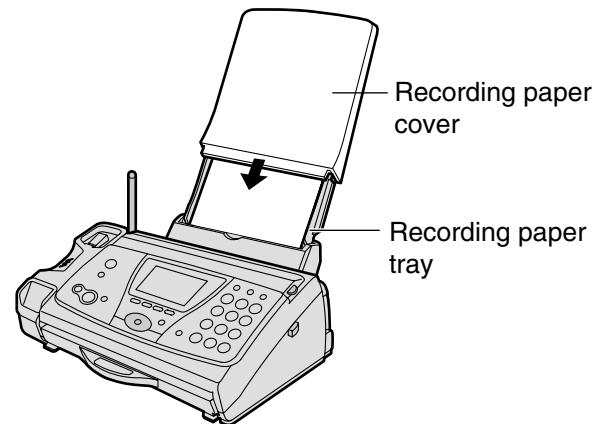

Installations and connections

Connecting the main unit

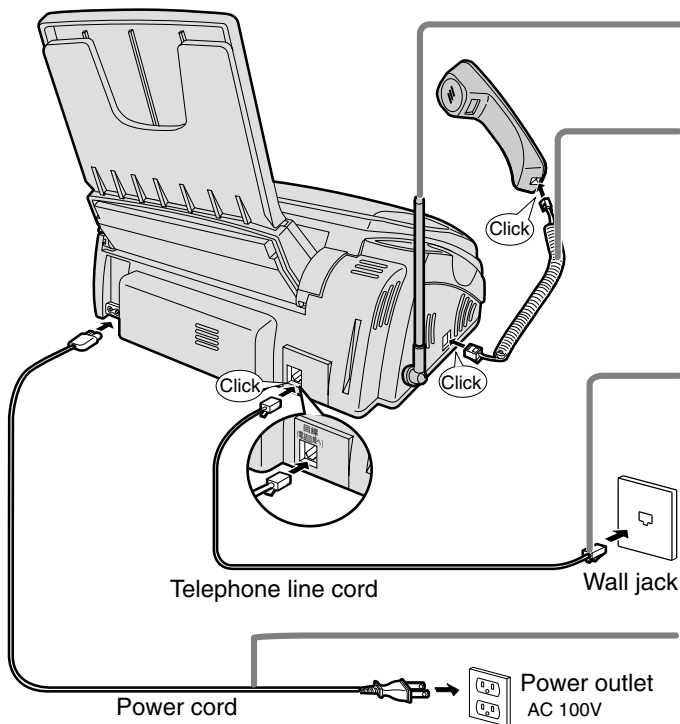

- 1** Raise the antenna.
- 2** Connect the cord and place the handset on the main unit.
- 3** Connect the telephone line cord (Supplied accessory).
- 4** Connect the power cord.

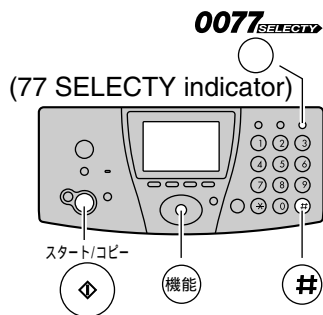

After the Power On...

After you will hear the following message about KDDI's 77 SELECTY service in Japanese (for about 2 minutes), this unit will automatically set up for 77 SELECTY service.

Thank you for purchasing a Panasonic facsimile. This unit will automatically select using KDDI's "0077" long distance call service. **If you do not want to use this service, press "機能 (Function)", "0077 (77 SELECTY)", and "#". Then, please make sure the "0077 (77 SELECTY indicator)" is turned off.**

If you want to start setting up for 77 SELECTY immediately, press ^{スタート/コピー} (Start).



This unit will automatically select the dialing mode (Tone/Pulse).



77 SELECTY indicator will light in green to show that 77 SELECTY service is ready to be used. (in an hour)

During the online setup, your telephone number will be sent to KDDI.

Installations and connections

Setting up the portable handset

1

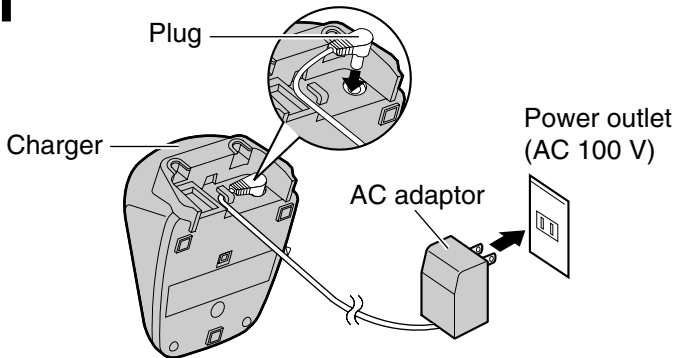

2

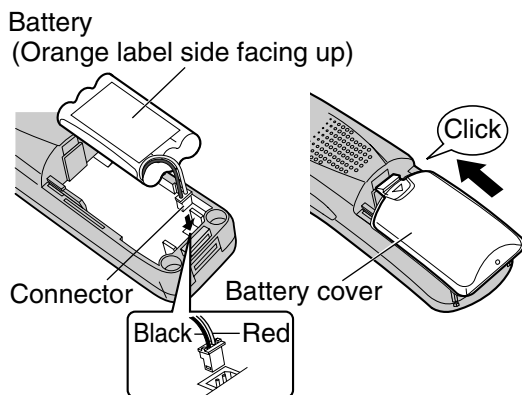

3 Charge the battery in the charger for 6 hours.

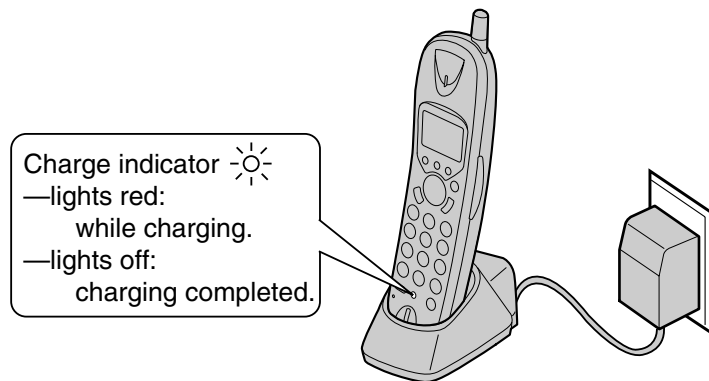

- After your Panasonic battery is fully charged, it will last up to about 7 hours of conversation.

Setting up the hand scanner

1

Press down the knob of the hand scanner, and pull out the hand scanner from the main unit.

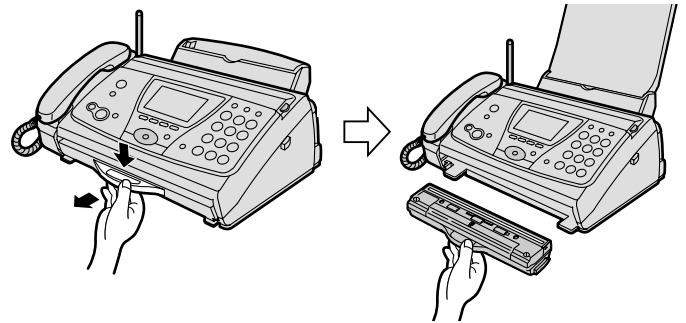

2

Slide and open the battery cover by slightly pushing  part.

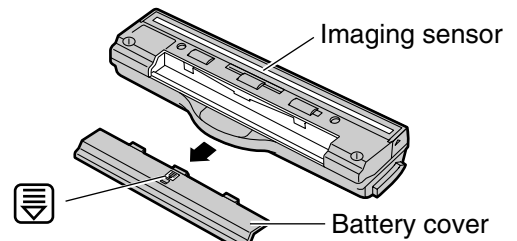

3

Connect the battery to the hand scanner, and close the battery cover.

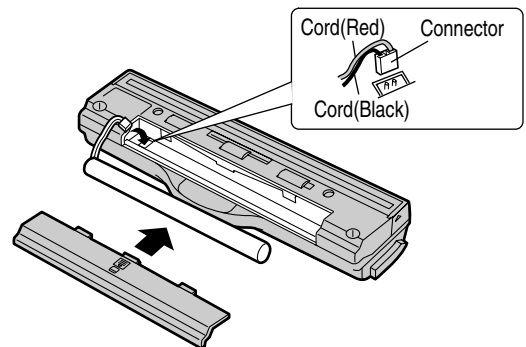

4

Insert the hand scanner, and charge the battery for 10 hours.

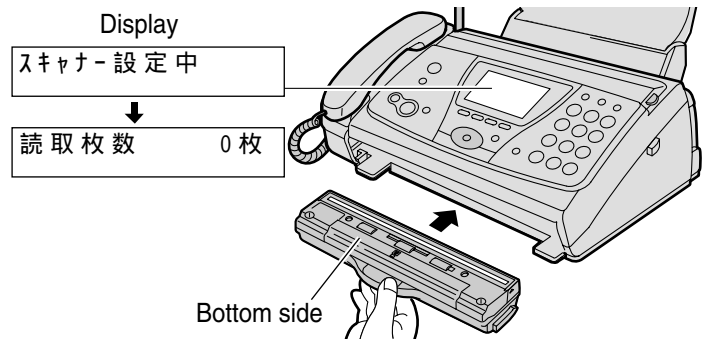

- The hand scanner battery is charged when the hand scanner is inserted into the main unit.

Setting the date and time

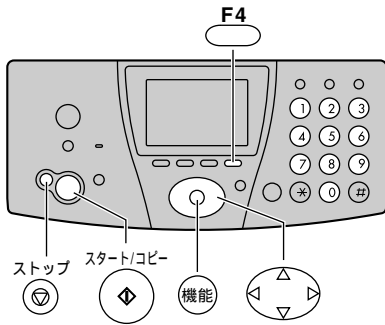

1 Press (Function).

機能登録モード

2 Press (Search button) repeatedly until the following is displayed.

最初の設定
[スタート] 押す

3 Press (Start).

Example : 2001年 01月 01日
00:00
Cursor

4 Enter the correct year/month/day.

Example: May 1, 2001

Press 2 0 0 1 0 5 0 1 .

2001年 05月 01日
00:00

5 Enter the correct hour/minute in a 24-hour clock entry.

Example: 15:45 (3:45 PM)

Press 1 5 4 5 .

2001年 05月 01日
15:45

6 Press (Register).

登録しました



2001年 05月 01日
15:45

7 Press (Stop).

Example : 5月 1日 15:45
用件録音 00件

Setting your facsimile telephone number

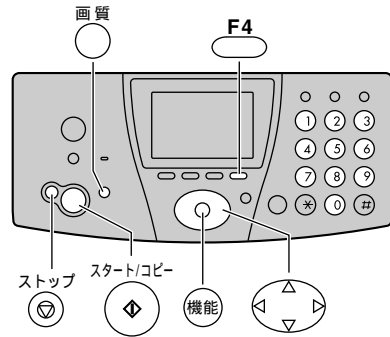

1 Press (Function).

機能登録モード

2 Press (Search button) repeatedly until the following is displayed.

最初の設定
[スタート] 押す

3 Press (Start).

Example : 2001年 05月 01日
15:45

4 Press (Search button) repeatedly until the following is displayed.

TEL=
Cursor

5 Enter your facsimile telephone number, up to 20 digits.

Example: 098 765 43..

TEL=98 765 43..

(Space) button replaces the digit with a space.

6 Press (Register).

登録しました



TEL=098 765 43..

7 Press (Stop).

Example : 5月 1日 15:45
用件録音 00件

Setting your logo

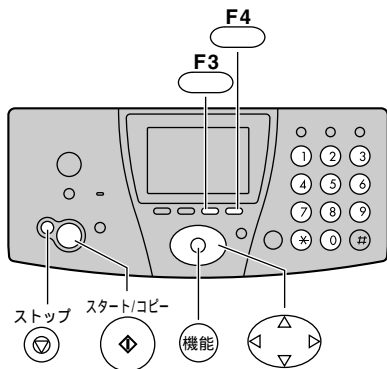

1 Press **機能** (Function).

機能登録モード

2 Press **検索** (Search button) repeatedly until the following is displayed.

最初の設定
[スタート] 押す

3 Press **スタート/コピー** (Start).

4 Press **検索** (Search button) repeatedly until the following is displayed.

名前(印字用)?

Cursor

5 Enter your logo, up to 30 characters, using the dial keypad.

- To enter English characters easily, press **文字切替 F3** (Character input mode) repeatedly and select “英” (English and sign input mode).
- For details, see the table on page 10 for instructions.

Example: Micah

1. Press **6** once.

M
Cursor

2. Press **4** six times.

Mi

3. Press **2** six times.

Mic

4. Press **検索** to move the cursor to the next space and press **2** four times.

Mic a

5. Press **4** five times.

Micah

6 Press **登録 F4** (Register).

登録しました



Micah
>_

7 Press **ストップ** (Stop).

Character input and command key table

Character Dial key	Pressing the dial keys will select a character as shown below.			
	“かな” Hiragana	“カナ” Katakana	“英” English	“数” Numbers
①	あいうえおあいうえお	アイウエオアイウエオ	@ . _ - & \$ ¥ % + = ~ ^	1
②	かきくけこ	カキクケコ	A B C a b c	2
③	さしすせそ	サシスセソ	D E F d e f	3
④	たちつてとっ	タチツテトッ	G H I g h i	4
⑤	なにぬねの	ナニヌネノ	J K L j k l	5
⑥	はひふへほ	ハヒフヘホ	M N O m n o	6
⑦	まみむめも	マミムメモ	P Q R S p q r s	7
⑧	やゆよやゆよ	ヤユヨヤユヨ	T U V t u v	8
⑨	らりるれろ	ラリルレロ	W X Y Z w x y z	9
⑩	わをんー！？()	ワヲンー！？()	! ? / - * # , ; : . ' ” () [] { } 「 」	0
✳	ゝ 〃 〃 〃		ゝ 〃	
Command keys	文字切替 F3 (Main unit), かな F2 (Portable handset)		Used to change the character input mode.	
	⬅️ (Main unit), ⬆️ (Portable handset)		Used to move the cursor to the left and right.	
	クリアー E1 (Main unit), クリアー キヤット (Portable handset)		Used to delete a character.	
	画質 (Main unit), フォクス (Portable handset)		Used to insert a space.	

- When entering e-mail address, the small letters are displayed before the capital letters.
- When entering e-mail address, you can not enter the following symbols: ゝ 〃 - 〃 「 」
- When entering e-mail address, you can enter only English and Numbers.
- When entering e-mail message, pressing (✳) enables you to begin the new line. (“↵” is displayed.)
- The display items of the main unit are somewhat different from that of the portable handset.

Automatic dialing on the main unit

Storing names and telephone numbers in the search button

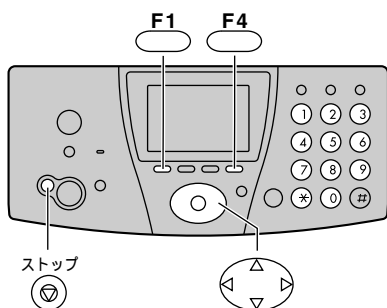

- 1 Press (Phonebook).
- 2 Press (Register).
 - “XXX” shows the number of remaining stations you can store.
 - You can program up to 150 stations, including 4 pre-programmed stations.
- 3 Enter the name, up to 12 characters (see the table on page 10 for instructions).
- 4 Press (Register) twice.
- 5 Enter the telephone number, up to 30 digits.
 - To correct a mistake, press (Clear).
- 6 Press (Register).
- 7 If necessary, enter the group number (1–9).
- 8 Press (Register).
 - To program other items, repeat steps 3–8.
- 9 Press (Stop) to exit the program.

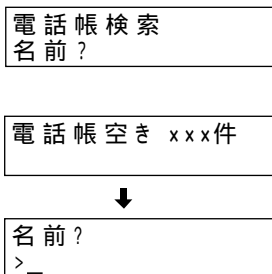

Making a voice call using the search button

- 1 Press (Phonebook).
- 2 Press (Search button) repeatedly until the desired name is displayed.
- 3 Lift the handset or press (Speakerphone).

Editing a stored name or number

- 1 Press (Phonebook).
- 2 Press (Search button) repeatedly until the desired name is displayed.
- 3 Press (Edit).
- 4 Edit the name (see the table on page 10 for instructions), then press (Register).
 - If you do not need to edit the name, press (Register) and skip to step 5.
- 5 Enter the correct kana, then press (Register).
 - If you do not need to edit the kana, press (Register) and skip to step 6.
- 6 Enter the correct telephone number, then press (Register).
 - If you do not need to edit the telephone number, press (Register) and skip to step 7.
- 7 If necessary, enter the correct group number.
- 8 Press (Register).

Automatic dialing on the portable handset

Storing names and telephone numbers in the search button

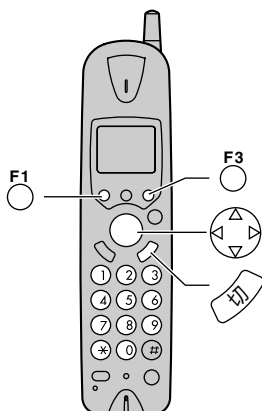

- 1 Press (Phonebook).
- 2 Press (Register).
 - “XXX” shows the number of remaining stations you can store.
 - You can program up to 150 stations, including 5 pre-programmed stations.
- 3 Enter the name, up to 12 characters (see the table on page 10 for instructions).
- 4 Press (Register) twice.
- 5 Enter the telephone number, up to 30 digits.
 - To correct a mistake, press (Clear).
- 6 Press (Register).
- 7 If necessary, enter the group number (1–9).
- 8 Press (Register).
 - To program other items, repeat steps 3–8.
- 9 Press (Off) to exit the program.

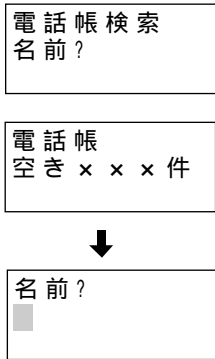

Making a voice call using the search button

- 1 Press (Phonebook).
- 2 Press (Search button) repeatedly until the desired name is displayed.
- 3 Press (Talk) or (Speakerphone).

Editing a stored name or number

- 1 Press (Phonebook).
- 2 Press (Search button) repeatedly until the desired name is displayed.
- 3 Press (Edit).
- 4 Edit the name (see the table on page 10 for instructions), then press (Register).
 - If you do not need to edit the name, press (Register) and skip to step 5.
- 5 Enter the correct kana, then press (Register).
 - If you do not need to edit the kana, press (Register) and skip to step 6.
- 6 Enter the correct telephone number, then press (Register).
 - If you do not need to edit the telephone number, press (Register) and skip to step 7.
- 7 If necessary, enter the correct group number.
- 8 Press (Register).
- 9 Press (Off) to exit the program.

Intercom between the main unit and portable handset

An intercom is available between the main unit and portable handset.

Using the main unit:

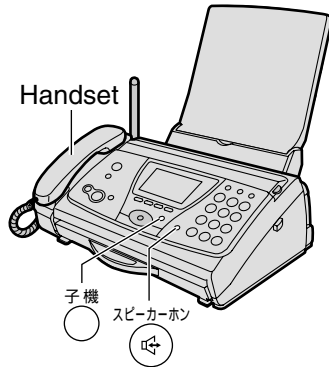

1 Lift the handset.

- When pressing  (Portable handset) instead of lifting the handset, you can use the speakerphone. Skip to step 3.

番号 ?

2 Press (Portable handset).

子機 1呼出中

3 When the portable handset user answers, start talking.

4 Replace the handset or press (Speakerphone) if using the speakerphone.

Using the portable handset:

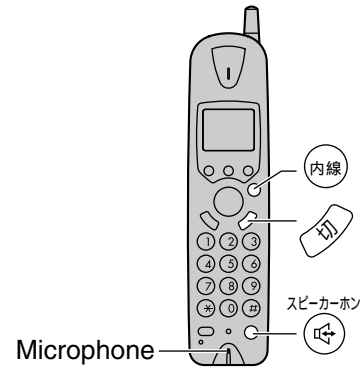

1 Press (Intercom).

内線呼出

2 When the main unit user answers, start talking.

- You can switch to the speakerphone by pressing  (Speakerphone).



内線通話中

3 Press (Off) to end the intercom call.

Sending faxes

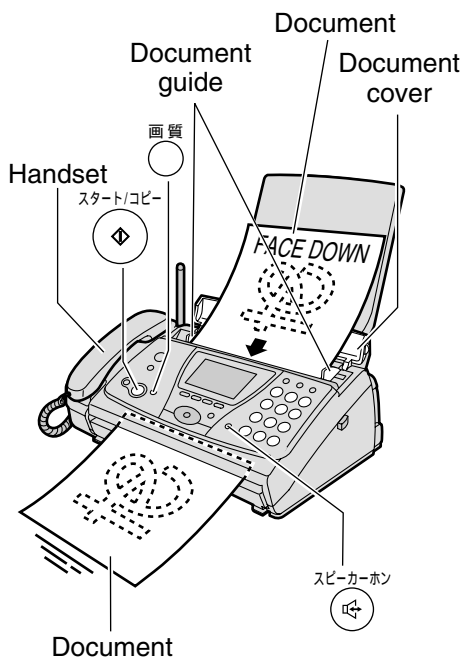



Sending a fax manually

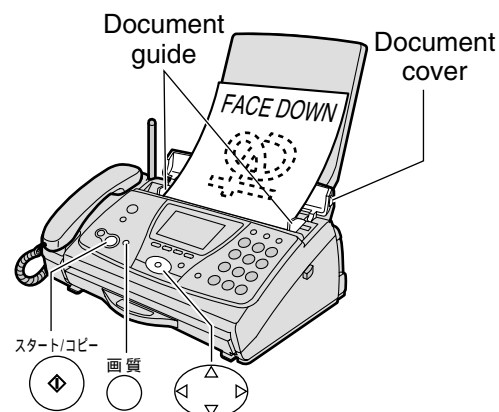

- 1 Open the document cover, and adjust the width of the document guides to the size of the document.
- 2 Insert the document (up to 5 pages) FACE DOWN until a single beep is heard.
- 3 If necessary, press  (Resolution) repeatedly to select the desired setting (see below).
- 4 Lift the handset or press  (Speakerphone).
- 5 Dial the fax number.
- 6 When a fax tone is heard, press  (Start).
- 7 Replace the handset if you are using it.
 - The unit will start fax transmission.

Sending a fax using the search button



- 1 Open the document cover, and adjust the width of the document guides to the size of the document.
- 2 Insert the document (up to 5 pages) FACE DOWN until a single beep is heard.
- 3 If necessary, press  (Resolution) repeatedly to select the desired setting (see below).
- 4 Press  (Phonebook).
- 5 Press  (Search button) until the desired name is displayed.
- 6 Press  (Start).
 - The unit will start fax transmission.

To select the resolution

Select the desired resolution according to the type of document, by pressing  (Resolution).

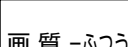
 (Standard) for printed or typewritten originals with normal-sized characters.

 (Fine) for originals with minute printing.

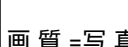
 (Photo) for originals containing photographs.

Receiving faxes

Receiving a fax manually (AUTO ANSWER off)

Using the main unit:

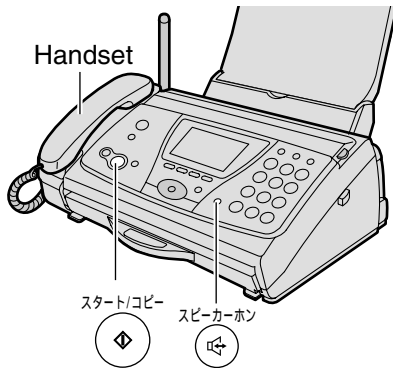

1 When you hear a ring, lift the handset or press (Speakerphone) to answer the call.

2 When:
 –document reception is required,
 –a fax calling tone (slow beep) is heard, or
 –no sound is heard,
 press (Start).

3 Replace the handset if you are using it.
 • The unit will start fax reception.

Using the portable handset:

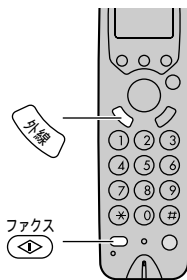

1 When you hear a ring, lift the portable handset from the charger to answer the call.
 • If the portable handset is not set on the charger, press (Talk).

2 When:
 –document reception is required,
 –a fax calling tone (slow beep) is heard, or
 –no sound is heard,
 press (Fax reception).
 • The main unit will start fax reception.

Setting ANSWER mode

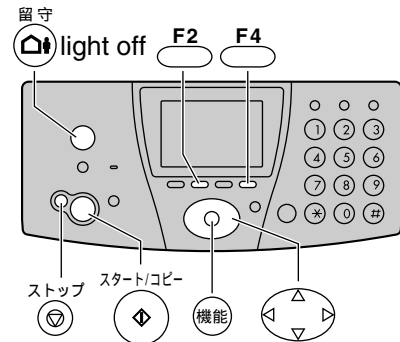

If the (Auto answer) light is on, turn it off by pressing .

When AUTO ANSWER mode is off, the unit provides two types of receiving modes: “電話優先” (Telephone) mode and “ファクス優先” (Fax/Telephone) mode.

Telephone mode (電話優先) –Pre-selected setting:
 Select this mode when you plan to answer the calls yourself.

When receiving calls, you have to answer all calls manually.

Fax/Telephone mode (ファクス優先):

Select this mode when you are near the unit and want to use it to receive voice calls yourself and fax calls automatically.

Change the setting if you want to use this mode.

1. Press (Function).
2. Press (Search button) repeatedly until the following is displayed.

ファクスの受け方を変更
[スタート] 押す

3. Press (Start).

4. Press (Select) repeatedly.

在宅 = 電話優先
 means “Telephone mode”

5. Press (Register).



在宅 = ファクス優先
 means “Fax/Telephone mode”

6. Press (Stop).

Receiving faxes

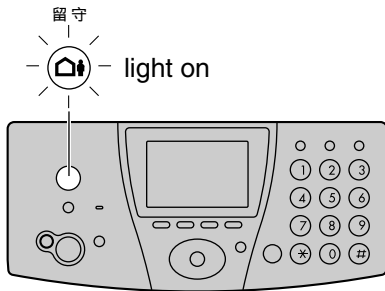
Receiving a fax automatically (AUTO ANSWER on)





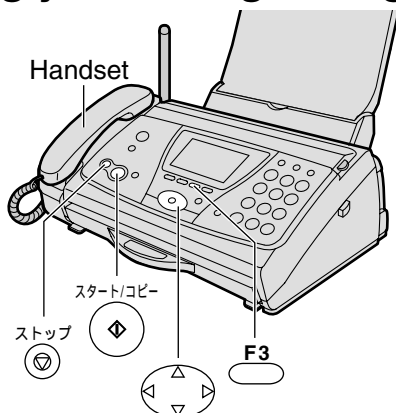

- 1 If the  (Auto answer) light is off, turn it on by pressing .
- 2 When receiving a call, the unit will receive a fax document or record a voice message automatically depending on the caller's request.

Recording your own greeting message





You can record your own greeting message. When receiving a call, it will be played to callers instead of the pre-recorded Japanese greeting message.

- 1 Press  (Record).
- 2 Press  (Search button) repeatedly until the following is displayed.

自作応答録音
[スタート] 押す
- 3 Press  (Start).
- 4 Lift the handset and press  (Start).
- 5 Record your greeting message, up to 16 seconds, using the handset.
- 6 Press  (Stop).
- 7 Replace the handset.
 - Your greeting message will be played back automatically.

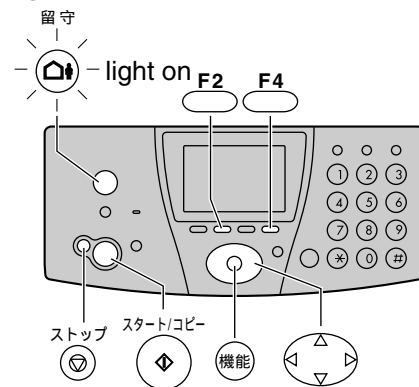
Setting AUTO ANSWER mode



AUTO ANSWER mode will work when the  (Auto answer) light is on.

AUTO ANSWER mode provides three types of receiving modes: “ファクス / 留守電” (Fax/Answering device) mode, “ファクス専用” (Fax only) mode and “留守電専用” (Answering device only) mode.

Fax/Answering device mode (ファクス / 留守電)

–Pre-selected setting:

Select this mode when you want to receive all voice and fax calls automatically.



Fax only mode (ファクス専用):

Select this mode when you wish to use the unit only as a fax machine.

Answering device only mode (留守電専用):

Select this mode when you wish to use the unit only as a telephone answering device.

Change the setting if you want to use the fax only mode or answering device only mode.

1. Press  (Function).
2. Press  (Search button) repeatedly until the following is displayed.



ファクスの受け方を変更
[スタート] 押す

3. Press  (Start).

4. Press  (Search button) repeatedly until the following is displayed.

留守 = ファクス / 留守電

5. Press  (Select) repeatedly to select the desired receiving mode.

6. Press  (Register), then press  (Stop).

Operating the built-in answering device

Activating the answering device

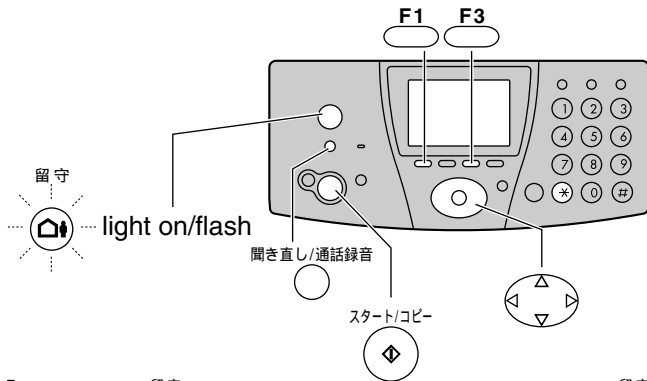

- 1 Turn the (Auto answer) light on by pressing .
- 2 When receiving a call, a greeting message will be played and the unit will record a voice message.
 - To record your own greeting message, see page 16.

Listening to recorded messages

When new messages are recorded, the (Auto answer) light will flash.

Press to listen to recorded messages.

Listening to all of the recorded messages

Press (Replay/Record).

Erasing a specific message

- 1 Press (Erase) while listening to the message you want to erase.

- 2 Press .

Erasing all of the recorded messages

- 1 Press (Record).

- 2 Press (Start), then press .

Erasing your own greeting message

- 1 Press (Record) and press (Search button) repeatedly until the following is displayed.

自作応答消去
[スタート] 押す

- 2 Press (Start) and press .

- The pre-recorded Japanese greeting message will be played when you receive a call.

Operating the answering device from a remote location

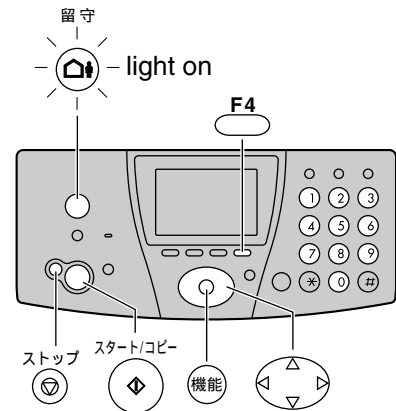

Preparation: Programming the remote operation ID

1. Press (Function).
2. Press (Search button) repeatedly until the following is displayed.

留守番電話の設定
[スタート] 押す

3. Press (Start).
4. Enter any 4-digit number (remote operation ID) except * or #.
5. Press (Register).
6. Press (Stop).

Operation: Listening to a recorded message from a remote location

Turn the (Auto answer) light on before you go out. Remote operations are available only from a touch tone telephone.

1. Call your unit.
2. Enter the remote operation ID during the greeting message.
3. Press or wait 4 seconds.
 - Only the new recorded messages will be played back.
 - To listen to all the recorded messages, press after the new messages have been played back.

Using the hand scanner

Scanning a document

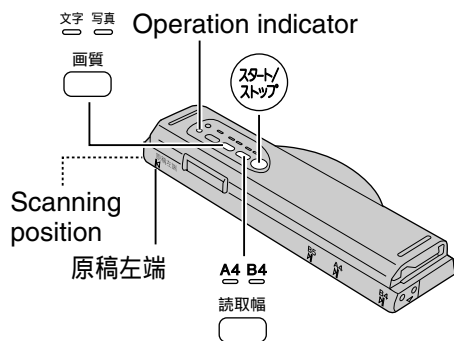

1 Press down the knob of the hand scanner, and pull out the scanner from the main unit. Then, turn it over.

2 Press (Resolution) repeatedly to select the desired resolution.

- Resolution types
 - 文字 (Letter: For documents that consist of letters)
 - 写真 (Photo: For documents containing photographs, etc.)

3 Press (Scanning width) repeatedly to select the desired width.

- Scanning width types
 - A4 (Within 208mm)
 - B4 (Within 252mm)

4 Place the scanning position and the 原稿左端 (Document's left end) on the document.

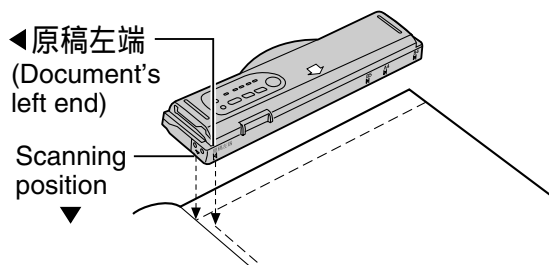

5 Press (Start).

- You will hear a beep, and the operation indicator will light green after about 1 or 2 seconds. You can start scanning after the operation indicator lights green.

6 Press the hand scanner against the document, and move it slowly towards the direction of the arrow (⇩).

- When it is scanning properly, the operation indicator will flash green.
- For the proper scanning speed for different resolution types, see "Scanning speed and memory capacity" on the bottom of this page.

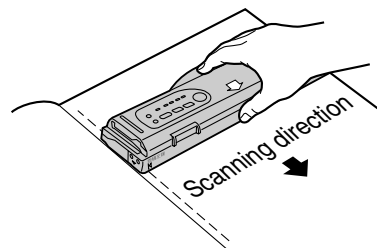

7 After scanning the document, press (Stop).

8 Insert the hand scanner in the main unit.

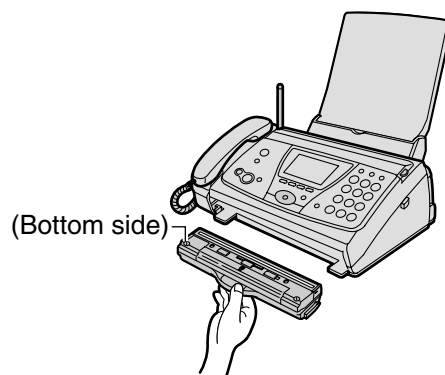

The number of scanned pages is displayed.

読取枚数 枚
印字は[スタート]押す

Scanning speed and memory capacity

When the (Letter) indicator lights on, the resolution type automatically changes according to the scanning speed.

Resolution indicator	Scanning speed	Resolution type	Memory capacity
文字 (Letter) light on	50mm/ 1 sec	Fine	Approx. 10 pages (document paper size-A4, 700 letters)
	100mm/ 1 sec	Standard	Approx. 20 pages (document paper size-A4, 700 letters)
写真 (Photo) light on	25mm/ 1 sec	-	Approx. 1 page (document paper size-A4, photo)

Using the hand scanner

Operation indicator and warning beep

When scanning documents, check the operation indicator light.

Operation Indicator	Warning Beep	Situation	Remedy
Green light Slow flash	No beep	The document is being scanned properly. (Fine letter mode)	
Green light Fast flash	No beep	The document is being scanned properly. (Standard letter mode)	
Green light ON	No beep	The hand scanner has temporarily stopped during scanning. You did not move the hand scanner for more than 30 seconds, so it has stopped scanning automatically.	To start scanning again, press  (Start).
Red light ON	No beep	The hand scanner is being moved quickly. (The document is being scanned.)	Move it more slowly.
Red light ON	1 beep	The hand scanner is being moved too quickly. (Some parts of the document may not be scanned, or the scanned contents may be too compressed.)	Move it more slowly.
Light OFF	3 beeps	The scanner memory is full. (The memory indicator green light will flash fast.)	Delete the contents scanned in the scanner (See page 22).
		You have scanned a document that is more than 1.5 m in length as 1 page.	Scan the document as 2 pages or more.
Light OFF	No beep	The scanner is not in operation.	

Memory indicator

Shows the amount of scanner memory being used.

Memory indicator (green light)	Memory used
OFF	0%
ON	~ 66%
Flash slow	~ 99%
Flash fast	100%

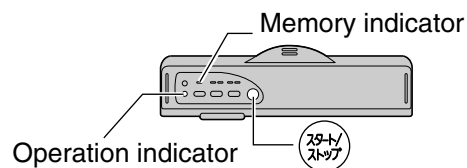

Using the hand scanner

Printing all pages of scanned content

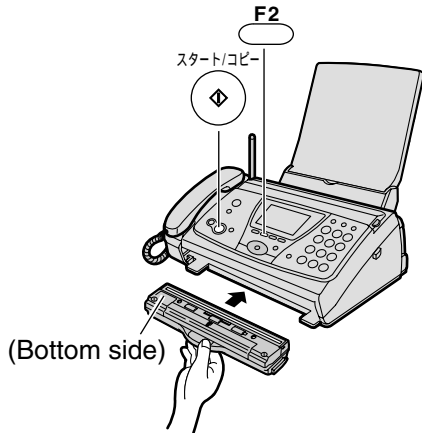

- 1 Insert the hand scanner in the main unit or press  (Scanner).
Example: 10 pages

読取枚数	10枚
印字は	[スタート] 押す

The number of scanned pages is displayed.

- 2 Press  (Start).

等倍=A4 A4
[スタート] 押す

- 3 Press  (Start).

印字中	1枚目
-----	-----

Printing a specific page of scanned content

- 1 Insert the hand scanner in the main unit or press  (Scanner).
Example: 10 pages

読取枚数	10枚
印字は	[スタート] 押す

The number of scanned pages is displayed.

- 2 Press  (Search button) repeatedly until the following is displayed.

^°-ジ° 指定印字
[スタート] 押す

- 3 Press  (Start).

開始 ^°-ジ° =01
[数字] 押す

- 4 Enter the number of the first page that you want to print using 2 digits.
Example: page 7

開始 ^°-ジ° =07
[数字] 押す

• To correct a mistake, press  (Clear).

- 5 Press  (Register).

終了 ^°-ジ° =07
[数字] 押す

- 6 Enter the number of the last page that you want to print using 2 digits.
Example: page 10

終了 ^°-ジ° =10
[数字] 押す

• To correct a mistake, press  (Clear).

- 7 Press  (Register).

等倍=A4 A4
[スタート] 押す

- 8 Press  (Start).
 - Printing will start.

印字中	7枚目
-----	-----

Using the hand scanner

Fax sending all pages of scanned content

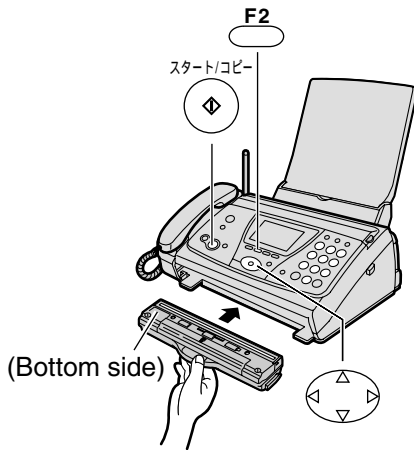

- 1 Insert the hand scanner in the main unit or press スキャナー **F2** (Scanner).
Example: 10 pages

読取枚数	10枚
印字は[スタート]	押す

 The number of scanned pages is displayed.

- 2 Press  (Search button) repeatedly until the following is displayed.

一括送信
[スタート]押す

- 3 Press スタート/コピー  (Start).

番号?

- 4 Dial the fax number.
Example: 09876543..

09876543..

- 5 Press スタート/コピー  (Start).
 • The unit will start fax transmission.

スキャナー-送信	1枚目
----------	-----

Fax sending a specific page of scanned content

- 1 Insert the hand scanner in the main unit or press スキャナー **F2** (Scanner).
Example: 10 pages

読取枚数	10枚
印字は[スタート]	押す

 The number of scanned pages is displayed.

- 2 Press  (Search button) repeatedly until the following is displayed.

^-ジ^ 指定送信
[スタート]押す

- 3 Press スタート/コピー  (Start).

開始 ^-ジ^ =01
[数字]押す

- 4 Enter the number of the first page that you want to send using 2 digits.
Example: page 7

開始 ^-ジ^ =07
[数字]押す

• To correct a mistake, press クリアー **F1** (Clear).

- 5 Press 登録 **F4** (Register).

終了 ^-ジ^ =07
[数字]押す

- 6 Enter the number of the last page that you want to send using 2 digits.
Example: page 10

終了 ^-ジ^ =10
[数字]押す

• To correct a mistake, press クリアー **F1** (Clear).

- 7 Press 登録 **F4** (Register).

番号?

- 8 Dial the fax number.
Example: 09876543..

09876543..

- 9 Press スタート/コピー  (Start).
 • The unit will start fax transmission.

スキャナー-送信	7枚目
----------	-----

Using the hand scanner

Deleting all pages of scanned content

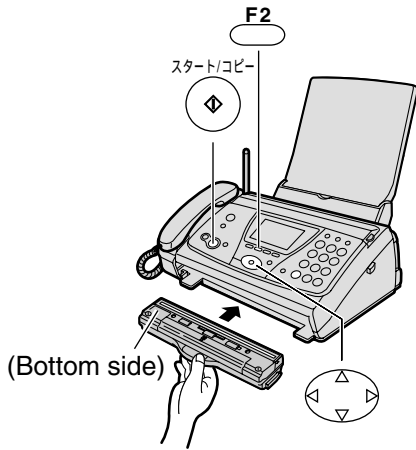

1 Insert the hand scanner in the main unit or press (Scanner).
Example: 10 pages 読取枚数 10枚
 印字は[スタート]押す
 The number of scanned pages is displayed.

2 Press (Search button) repeatedly until the following is displayed.
 一括消去 [スタート]押す

3 Press (Start).
 すへて消去しますか?
 はい=* いいえ=#

4 Press .
 • Deleting will start.
 消去しました
 ↓
 読取枚数 0枚

Deleting the last page of scanned content

1 Press (Erase) until a beep is heard (Approx. 2 secs).
 • The last page will be deleted.

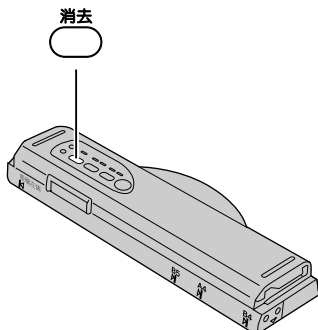

Deleting a specific page of scanned content

1 Insert the hand scanner in the main unit or press (Scanner).
Example: 10 pages 読取枚数 10枚
 印字は[スタート]押す
 The number of scanned pages is displayed.

2 Press (Search button) repeatedly until the following is displayed.
 ^°-ジ°指定消去 [スタート]押す

3 Press (Start).
 開始^°-ジ°=01 [数字]押す

4 Enter the number of the first page that you want to delete using 2 digits.
Example: page 7 開始^°-ジ°=07 [数字]押す

• To correct a mistake, press (Clear).

5 Press (Register).
 終了^°-ジ°=07 [数字]押す

6 Enter the number of the last page that you want to delete using 2 digits.
Example: page 10 終了^°-ジ°=10 [数字]押す

• To correct a mistake, press (Clear).

7 Press (Register).
 消去しますか?
 はい=* いいえ=#

8 Press .
 • Deleting will start.
 消去しました

Example: 読取枚数 6枚
 印字は[スタート]押す

Individual e-mail services

Using the e-mail services

Kyushu Matsushita Electric Co., Ltd. (hereafter called "KME") offers individual information services, such as e-mail.

Your fax machine with e-mail features will be able to send an e-mail to another party's personal computer (PC) or another e-mail fax machine anywhere in the world through the Internet. Also, you will be able to receive an e-mail from them.

To access the Internet using your fax machine, you have to subscribe to the following services beforehand.

- 77 SELECTY services offered by the KDDI, and
- Individual information services offered by KME.

When the  indicator is off, you need to activate the service. Please refer to "Setting up 77 SELECTY services" in the right column.

Important:

- If your fax machine is connected to a home telephone system or a private branch exchange (PBX) system, these services are not available.

Application fee and call charges

KDDI  services	Registration fee	Free
KME information services	Registration fee	¥500
	Call charge	¥10/minute (8 am-11 pm) ¥8.5/minute (11 pm-8 am)
	Information service fee	¥5/30 s

- As of May 2001.
- Tax not included.

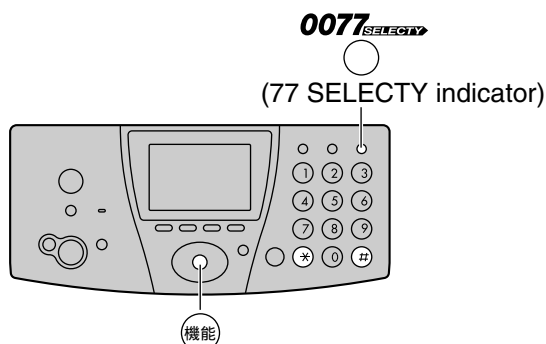

KME information services



The following services are available with your fax machine. A call charge and information service fee will be applied.

- Text e-mail sending (page 25)
- Fax e-mail sending (page 26)
- Voice e-mail sending (page 26)
- Storing another party's e-mail address (free of charge) (page 27)
- E-mail reception and printing (page 28)
- Voice e-mail listening (page 28)
- Others

Note:

- KME plans to add new information services and the information service fee is subject to change. KME will announce them by e-mail to its customers.
- For the PC user to view your fax e-mail or to hear your voice e-mail sent from your fax machine, the following PC software will be required.
 - E-mail software that can read the MIME format
 - TIFF viewer software
 - WAV sound player software and sound system

Setting up 77 SELECTY services

1 Press  (Function) and press .

77セレクトイ=なし
[あり=*, なし=#]

2 Press .

登録しました



KDDIへ連絡します

- Your telephone number will be sent to KDDI.
- After about 1 minute, an online data communication will start between your unit and KDDI. After the communication has been completed, the  indicator will turn green.

Note:

- Please contact KDDI Customer Service Center at 0077 772 (dial toll free) 9 am-9 pm in the following case:
 - If you are subscribing to NTT's discount service plan. (It may become ineffective by selecting 77 SELECTY services.)

Individual e-mail services

Subscribing to KME information services

- 1** Confirm that the **0077 SELECTY** indicator is green.
- If the indicator is off, change the setting for 77 SELECTY (see page 23).

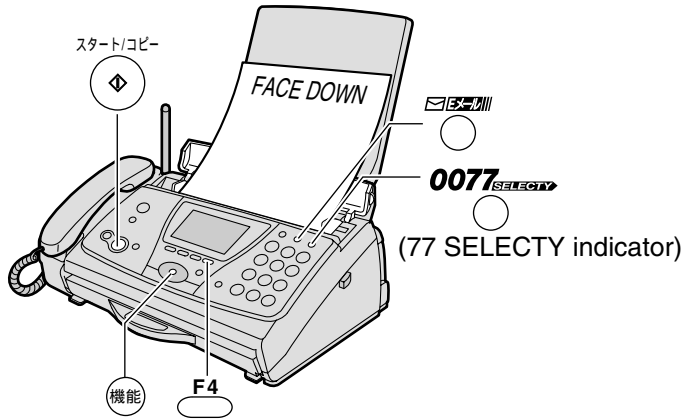

- 2** Fill in the included application form.

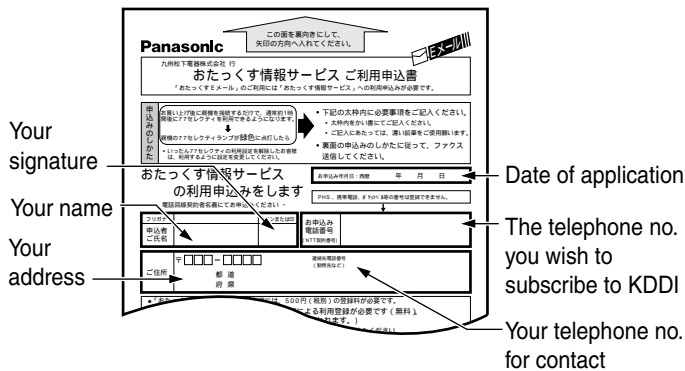

- 3** Press **機能** (Function).

- 4** Press **E-mail** (E-mail).

- 5** Press **スタート/コピー** (Start).
- Your telephone number will be displayed.

- 6** Press **登録 F4** (Register).

- 7** Insert the application form FACE DOWN.

- 8** Press **スタート/コピー** (Start).
- The unit will start fax transmission.
 - After the fax transmission is completed, the following report will be printed.

Example:

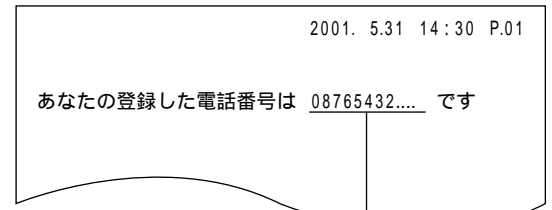

Confirm your telephone number.

- 9** After approx. 5 minutes, the unit will ring, and a data communication will start automatically between your unit and KME.
- If you answer this call, hang up immediately and wait for a while until the communication is completed.

- 10** When the communication is completed, a user registration form will be printed.

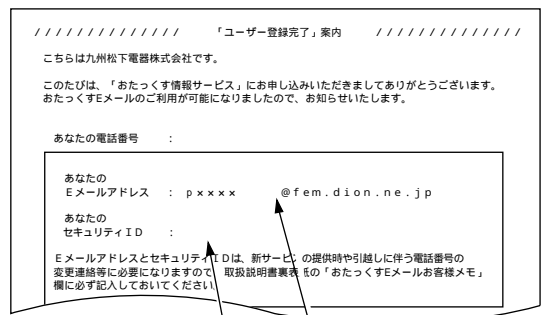

Your e-mail address

Your security ID code

- Please save the address and ID code for future reference.

- 11** Press **E-mail** (E-mail).

- 12** Press **スタート/コピー** (Start).
- An information service guide will be printed.

Individual e-mail services

Sending a text e-mail from the main unit

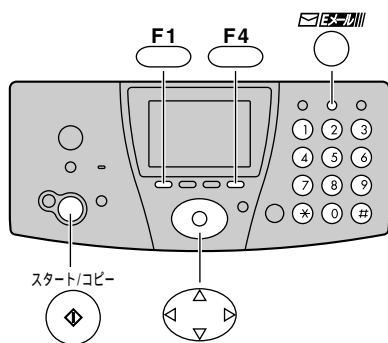

- 1 Press (E-mail).
- 2 Press (Search button) repeatedly until the following is displayed.

文字Eメール送信
 [スタート] 押す
- 3 Press (Start).
- 4 Enter the desired e-mail address (see the table on page 10 for instructions) and press (Register).
 - You can select the desired address using (Search button), then pressing (Decision). Then, press (Register). To store an address, see page 27.
- 5 Press (Register).
 - The display will show the last title you entered. To delete this title, press (Clear) for 2 or more seconds.
- 6 Enter the title of your e-mail, up to 32 characters (see the table on page 10 for instructions).
- 7 Press (Register).
 - The display will show the last message you entered. To delete this message, press (Clear) for 2 or more seconds.
- 8 Enter your e-mail message, up to 200 characters (see the table on page 10 for instructions).
- 9 Press (Register).

Sending a text e-mail from the portable handset

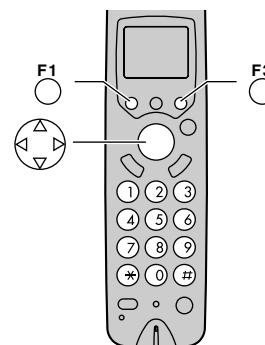

- 1 Press (Function), then press (E-mail).
- 2 Press (Decision).
- 3 Enter the desired e-mail address (see the table on page 10 for instructions) and press (Register).
 - You can select the desired address using (Search button), then pressing (Decision). Then, press (Register). To store an address, see page 27.
- 4 Press (Register).
 - The display will show the last title you entered. To delete this title, press (Clear) for 2 or more seconds.
- 5 Enter the title of your e-mail, up to 32 characters (see the table on page 10 for instructions).
- 6 Press (Register).
 - The display will show the last message you entered. To delete this message, press (Clear) for 2 or more seconds.
- 7 Enter your e-mail message, up to 200 characters (see the table on page 10 for instructions).
- 8 Press (Register), then press (Register).

Individual e-mail services

Sending a fax e-mail

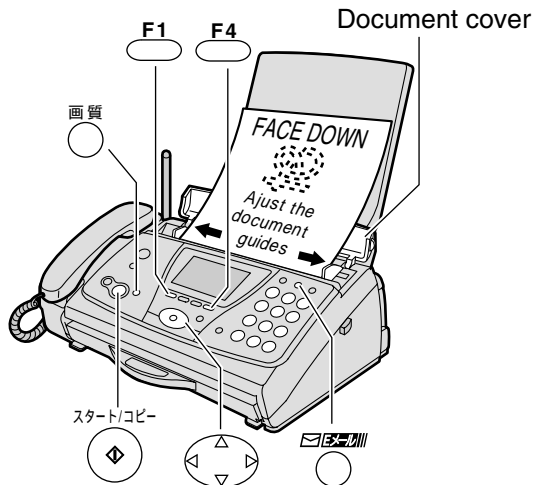

- 1** Open the document cover, and adjust the width of the document guides to the size of the document.
- 2** Insert the document (up to 5 pages) FACE DOWN until a single beep is heard.
- 3** If necessary, press (Resolution) repeatedly to select the desired setting (see page 14).
- 4** Press (E-mail).
- 5** Press (Start).
- 6** Enter the desired e-mail address (see the table on page 10 for instructions) and press (Register).
 - You can select the desired address using (Search button), then pressing (Decision). Then, press (Register).
To store an address, see page 27.
- 7** Press (Register).
 - The display will show the last title you entered. To delete this title, press (Clear) for 2 or more seconds.
- 8** Enter the title of your fax e-mail, up to 32 characters (see the table on page 10 for instructions).
- 9** Press (Register).

Sending a voice e-mail

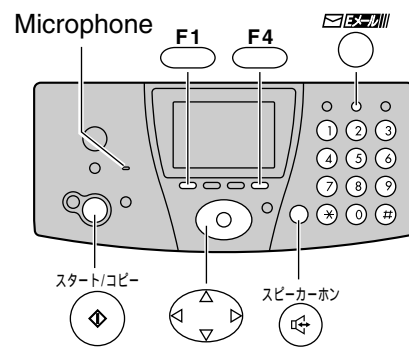

- 1** Press (E-mail).
- 2** Press (Search button) repeatedly until the following is displayed:

音声メール送信
[スタート] 押す
- 3** Press (Start).
- 4** Enter the desired e-mail address (see the table on page 10 for instructions) and press (Register).
 - You can select the desired address using (Search button), then pressing (Decision). Then, press (Register).
To store an address, see page 27.
- 5** Press (Register).
 - The display will show the last title you entered. To delete this title, press (Clear) for 2 or more seconds.
- 6** Enter the title of your e-mail, up to 32 characters (see the table on page 10 for instructions).
- 7** Press (Register).
 - An announcement about how to record will be heard.
- 8** Record your voice message up to 60 seconds, following voice guidance, using the microphone or the handset.
- 9** Press (Speakerphone) to finish recording, or replace the handset if you are using it.

Individual e-mail services

Storing another party's e-mail address in the search button

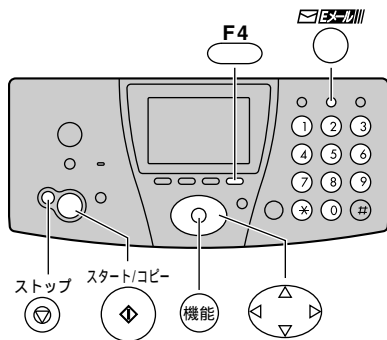

- 1 Press (Function).
- 2 Press (E-mail).
- 3 Press (Search button) repeatedly until the following is displayed.

アドレス帳登録
[スタート] 押す
- 4 Press (Start).
- 5 Enter the name, up to 12 characters (see the table on page 10 for instructions).
- 6 Press (Register) twice.
- 7 Enter the e-mail address, up to 60 characters (see the table on page 10 for instructions).
- 8 Press (Register).
 - To program other items, repeat steps 5–8.
 - You can store up to 30 stations.
- 9 Press (Stop) to exit the program.

Editing a stored e-mail address

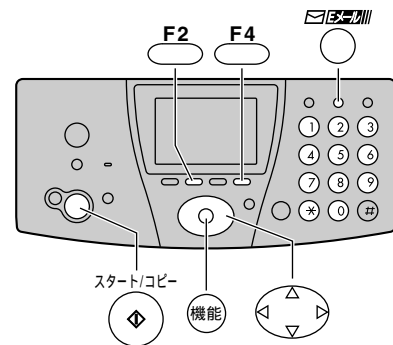

- 1 Press (Function).
- 2 Press (E-mail).
- 3 Press (Search button) repeatedly until the following is displayed.

アドレス帳確認
[スタート] 押す
- 4 Press (Start).
- 5 Press (Search button) repeatedly until the desired name is displayed.
- 6 Press (Edit).
- 7 Edit the name (see the table on page 10 for instructions).
 - If you do not need to edit the name, press (Register) and skip to step 9.
- 8 Press (Register).
- 9 Edit the kana (see the table on page 10 for instructions).
 - If you do not need to edit the kana, press (Register) and skip to step 11.
- 10 Press (Register).
- 11 Edit the e-mail address (see the table on page 10 for instructions).
 - If you do not need to edit the e-mail address, skip to step 12.
- 12 Press (Register).

Individual e-mail services

Receiving and printing an e-mail

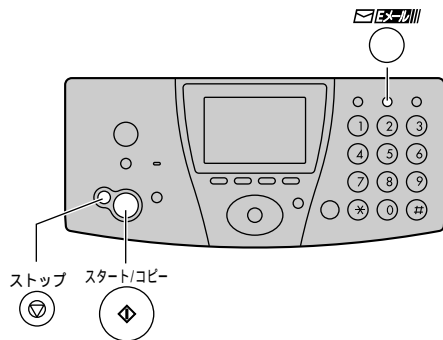

1 Press  (E-mail).

2 Press  (Start).

- If there is an e-mail you have not viewed yet:

Eメール通信中

The unit will print the received e-mail.

- If there is no e-mail:

未受信Eメール 0件

Press  (Stop).

The file formats recognized by your fax machine are:

- JPEG • ~. doc
- TIFF • ~. xls
- BMP • ~. ppt
- TXT • ~. pdf
- WAV

(as of May 2001)

Listening to a received voice e-mail in an attached file

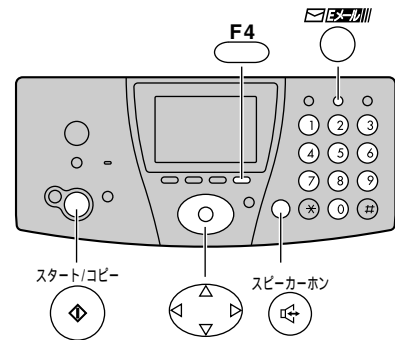

1 Press  (E-mail).

2 Press  (Search button) repeatedly until the following is displayed.

音声Eメール受信
[スタート] 押す

3 Press  (Start).

4 Enter the document number with 4 digits.

- See the example below about document number.

5 Press  (Register).

6 Listen to an announcement through the speaker or the handset.

7 Listen to the voice message following voice guidance.

8 Press  (Speakerphone) to finish listening, or replace the handset if you are using it.

Note:

- You can hear a voice in WAV format only.
- Voice data will be saved for 1 week in the server after the e-mail has been received.

Connecting a computer

You can access the Internet using the computer connected to the portable handset.

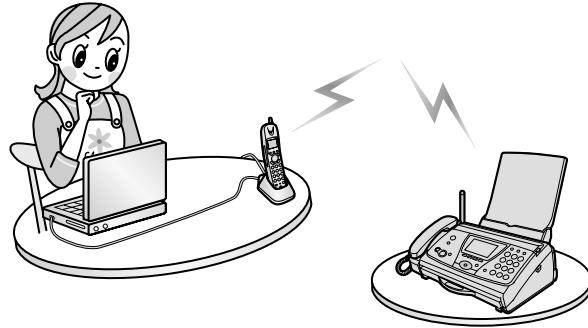

1 Connect to the computer.

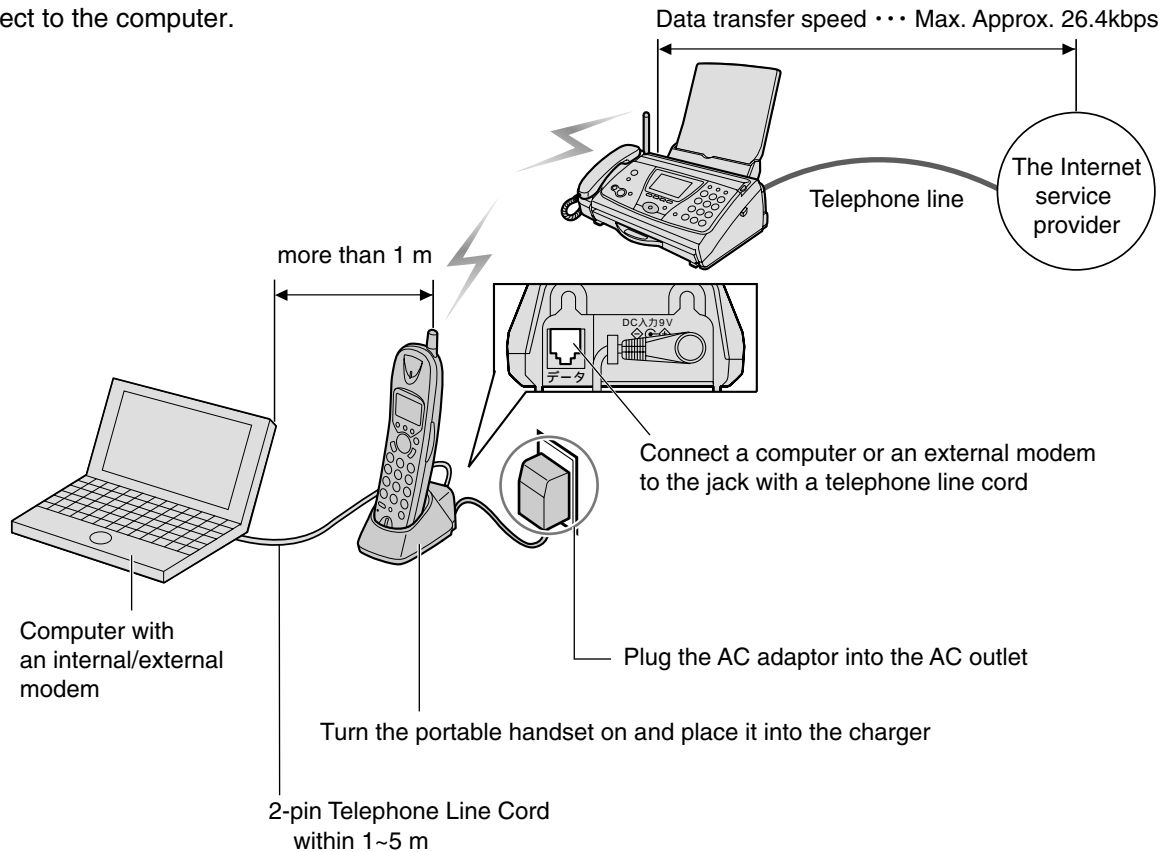

2 Prepare the portable handset for communicating.

- 1 Insert the portable handset, with the power turned on, into the charger.
- 2 Place the portable handset and the charger so that the portable handset display shows 3 or more bars. (~)

3 Set up the computer.

- 1 If you want to access the Internet, you have to subscribe to an Internet service provider.
- 2 Set up your computer following the instructions provided by your provider.
- 3 Set the dialing mode to "Tone".
- 4 Turn the dial tone detection on.

4 Operate the computer.

Connecting a BS digital tuner / Digital CS tuner

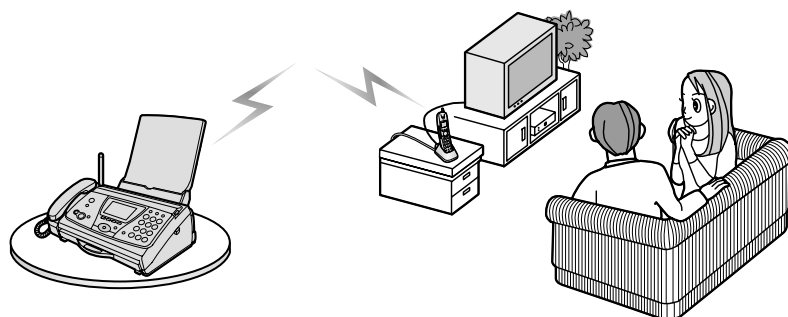

The portable handset allows you to enjoy BS / CS digitally broadcast shopping programs or interactive digital quiz and pay TV programming. (Contact the broadcasting company for program fees and other details.)

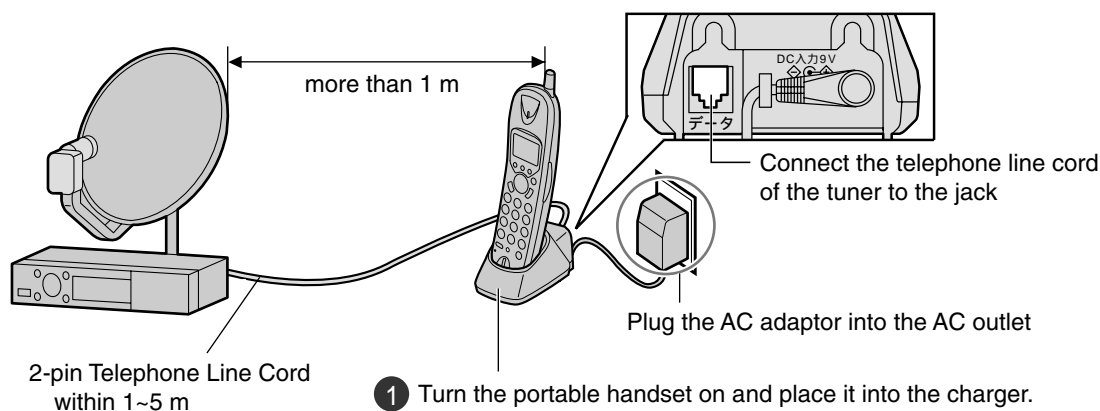

1 Connect to the BS digital tuner / Digital CS tuner.



1 Turn the portable handset on and place it into the charger.

2 Place the portable handset and the charger so that the portable handset display shows 3 or more bars. ( ~ )

2 Set up the BS digital tuner / Digital CS tuner.

- 1 Set the dialing mode to "Tone".
- 2 Turn the dial tone detection on.
- 3 After all the connections and settings are completed, check to make sure the BS digital tuner / Digital CS tuner is ready for communication.

Note:

- You cannot use the BS digital tuner / Digital CS tuner when the dial line is at speeds of 10pps.
- You cannot use the Digital CS tuner when the dial line is at speeds of 20pps.
- If you connect this unit to ISDN Lines, you cannot use this feature.
When you use Matsushita ISDN Terminal Adaptor (Part no. T0-TAB128D2), you can use Matsushita BS Digital Hi-vision TV (Part no. TH-36D10) and BS Digital Hi-vision Tuner (Part no. TU-BHD100).
- If you connect this unit to a PBX or an adaptor which automatically selects a telephone line, you might not use this feature.

3 Operate the BS digital tuner / Digital CS tuner.

Specifications

KX-PW301DL	Main unit	Hand scanner
Power supply	AC 100 V (50 Hz/60 Hz)	Ni-Cd battery (Part no. KX-FAN38) DC 3.6 V, 600 mAh
Power consumption	Transmission: Approx. 17 W Reception: Approx. 18 W Copy: Approx. 20 W Stand by: Approx. 2.1 W Maximum(*1): Approx. 120 W	
Dimensions (H x W x D)	Approx. 139 X 344 X 262 mm (without projections) Approx. 378 X 344 X 310 mm (recording paper tray installed)	Approx. 35 X 274 X 81 mm (without projections)
Mass (Weight)	Approx. 3.9 kg (10 m ink film installed)	Approx. 340 g (battery installed)
Operating environment	5 °C – 35 °C, 45 % – 85 % RH (Relative Humidity)	
Applicable line	Public Switch Telephone Network (Tone/Pulse), F-Net, NCC Lines	
DC resistance	320 Ω (*2)	
Compatibility	G3 compatible	
Document size	B4-A5 (Max. 257 mm in width, Max. 800 mm in length)	
Effective scanning size	252 mm (B4) 208 mm (A4)	Max. 252 mm (B4)
Effective printing size	202 mm (A4 size plain paper)	
Transmission time	Approx. 15 s/page (Original mode) (*3)	
Modem speed	9,600 / 7,200 / 4,800 / 2,400 bps; Automatic fallback	
Halftone level	64-level	
Scanning density	Horizontal: 8 pels/mm Vertical: 7.7 lines/mm (Fine/Photo), 3.85 lines/mm (Standard)	Horizontal: 8 pels/mm Vertical: 7.7 lines/mm
Scanner type	CCD image sensor	
Printer type	Thermal transfer printing on plain paper	
Data compression system	Modified Huffman (MH), Original mode	
Recording paper size	A4: 210 mm x 297 mm (Plain paper)	
Answering device	Greeting message: Digital recording system (up to 16 sec) Pre-recording greeting message ICM Recording: Digital recording system (Approx. 18 min. in total) (*4)	
Memory capacity	Max. Approx. 42 pages (Only receiving fax etc.) (*5) Max. Approx. 18 min. (Only Recording message) (*4)	20 pages Text (Standard) (*5) 10 pages Text (Fine) (*5) Approx. A4 1 page (Photo)
Talk time during power failure	After the hand scanner battery has been charged for about 10 hours: • Successive talk time :Approx. 90 min. • Standby time :Approx. 10 hours	
Wireless communication	Max. 26.4 kbps	
Data communication	Portable handset / Main unit: 64 kbps based on PIAFS Ver 2.0 Main unit / NTT Lines: Max. 56 kbps (receiving) Max. 33.6 kbps (transferring)	

*1 When copying a 100% black document.

*2 If you cannot make a call due to DC resistance, consult your dealer.

*3 Transmission speed is based on an A4-size document of 700 characters sent in standard resolution at 9,600 bps. The actual transmission speed depends upon the contents of the page, resolution, telephone line conditions and capability of the other party's machine.

*4 If there is a silent pause, the total recording time will be longer.

*5 The memory capacity is based on an A4-size document of 700 characters.

Specifications

KX-PW301DL	Portable handset	Battery charger
Power supply	Ni-MH battery (Part no. KX-FAN39) DC 3.6 V, 600 mAh	AC adaptor (Part no. KX-A12N) AC 100 V (50 Hz/60 Hz) DC 9 V, 200 mA
Power consumption		<ul style="list-style-type: none"> • Charging: Approx. 2.7 W • Stand by: Approx. 1.4 W
Dimensions (H x W x D)	Approx. 181 X 44 X 40 mm (without projections) Approx. 196 X 44 X 40 mm (including antenna)	Approx. 60 X 80 X 105 mm
Mass (Weight)	Approx. 170 g (battery installed)	Approx. 87 g
Operating environment	5 °C – 35 °C, 45 % – 85 % RH (Relative Humidity)	
Compatibility	Digital	/
Usable time	Successive talk time: Approx. 7 hours Successive talk time: Approx. 7 hours (Transceiver) Stand by: Approx. 700 hours Stand by: Approx. 100 hours (Transceiver) 56K data transmission time: Approx. 6 hours (not in charger)	
Charging time	Approx. 6 hours	
Usable distance	Approx. 100 m	